



12V90AH



Features:

- ◆ Maintenance-free operation
- ◆ Stable quality and high reliability
- ◆ Compact design
- ◆ 10 years design time (at 25°C)

Applications

- ◆ UPS
- ◆ Emergency lighting
- ◆ Fire alarm and security systems
- ◆ Telecommunication system
- ◆ Backup power for testing and measuring instruments
- ◆ Alarm and security system
- ◆ Electronic apparatus and equipment
- ◆ Communication power supply
- ◆ DC power supply
- ◆ Auto control system

Specifications

Nominal Voltage	12V(6cells)
Nominal Capacity	90AH (10hr, 1.80V/cell, 25°C/77°F)
	76.5AH (5hr, 1.75V/cell, 25°C/77°F)
	54AH (1hr, 1.60V/cell, 25°C/77°F)
Dimension	Length 306±2mm
	Width 168±2mm
	Container Height 210±2mm
	Total Height(with Terminal) 214±3mm
Approx Weight	Approx 27.0Kg
Terminal	T3 or F5
Container Material	ABS
Max. Discharge Current	900A(5S)
Internal Resistance	Approx 6.0mΩ

Operating Temp. Range	Discharge: -15—50 °C(5—122 °F)	
	Charge : 0—40°C(32—104°F)	
	Storage : -15—40 °C(5—104 °F)	
Nominal Operating Temp. Range	25±3°C(77±5°F)	
Cycle Use	14.4~14.8V(25°C/77°F)Temp.Coefficient-30mV/°C	
	Initial Charging Current Less than 16.5A	
Standby Use	13.5V~13.8V(25°C/77°F)Temp.Coefficient-20mV/°C	
	No limit on Initial Charging Current	
Capacity affected by Temperature	40°C(104°F)	103%
	25°C(77°F)	100%
	0°C(32°F)	86%

Self Discharge  batteries may be stored for up to 6months

at 25°C(77°F)and then a freshening charge is required.
For higher temperatures the time interval will be shorter.

Constant Current Discharge(Amperes at 25°C/77 °F)

F.V/Time	10min	15min	30min	45min	1h	2h	3h	5h	10h	20h
1.80V/cell	161	131	82	63	51.3	30.0	22.5	15.5	9.1	4.68
1.70V/cell	189	154	88	68	54.5	31.7	23.6	16.0	9.3	4.82
1.60V/cell	212	170	97	73	58.5	33.5	24.7	16.7	9.5	4.95

Constant Power Discharge (Watts per cell at 25°C/77 °F)

F.V/Time	10min	15min	30min	45min	1h	2h	3h	5h	10h	20h
1.80V/cell	295	249	154	120	99.9	57.7	43.7	30.6	18.0	9.26
1.70V/cell	333	275	166	129	103.6	60.7	45.5	31.4	18.3	9.50
1.60V/cell	363	298	180	136	110.3	63.2	47.2	32.2	18.5	9.74

Note: The above characteristics data are average values obtained within three charge/discharge cycles, not the minimum values.

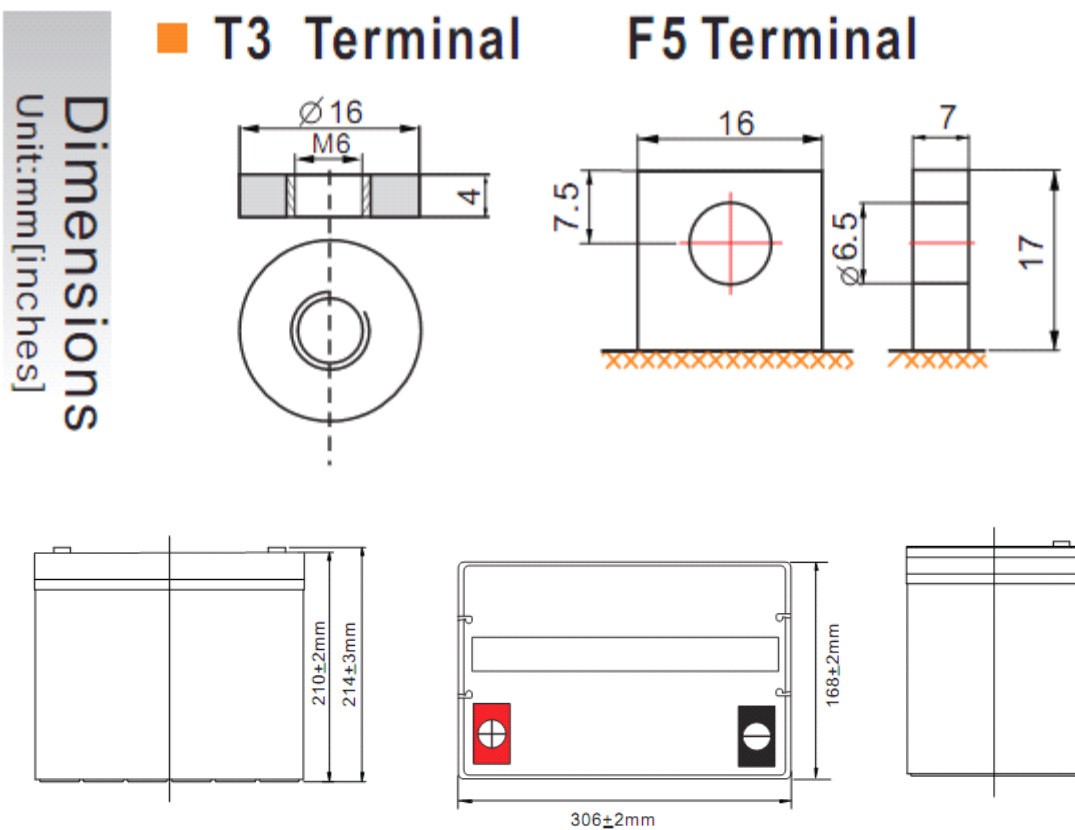

Storage characteristics

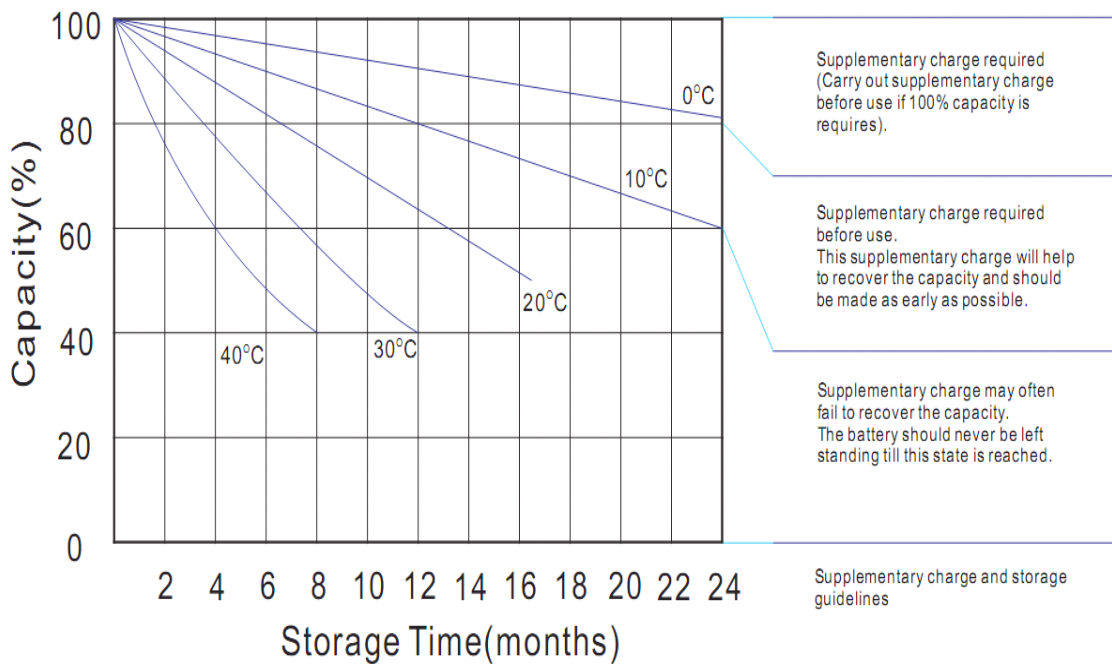

Effect of temperature on long term float life

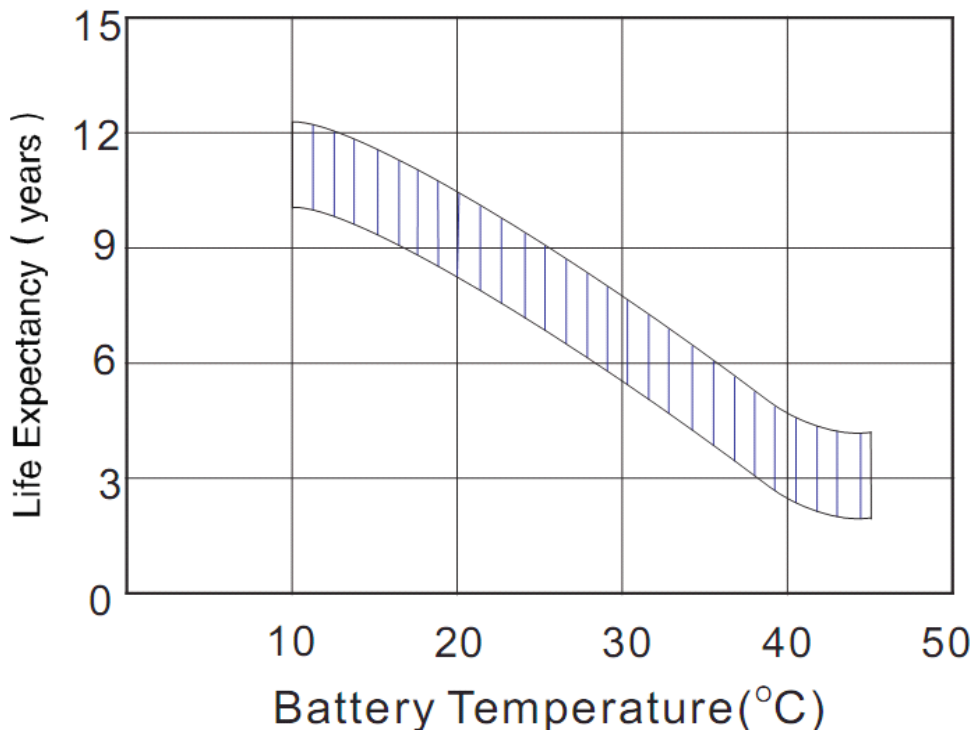

Charge characteristic Curve for standby use

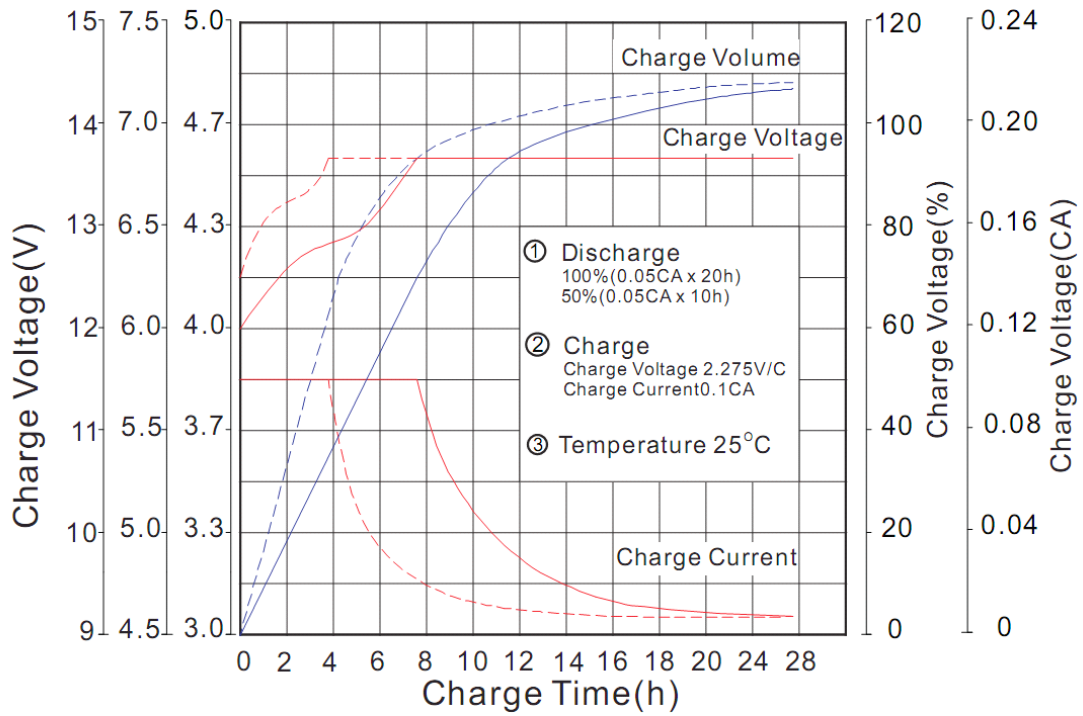

Discharge characteristic Curve

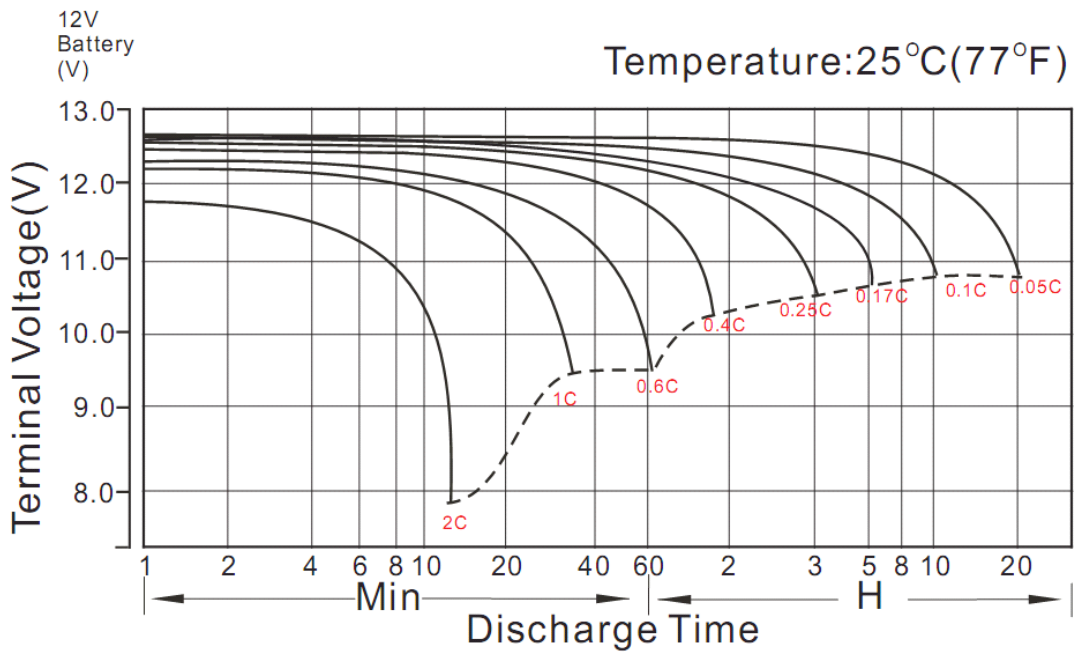

Temperature Effects in Relation to Battery Capacity

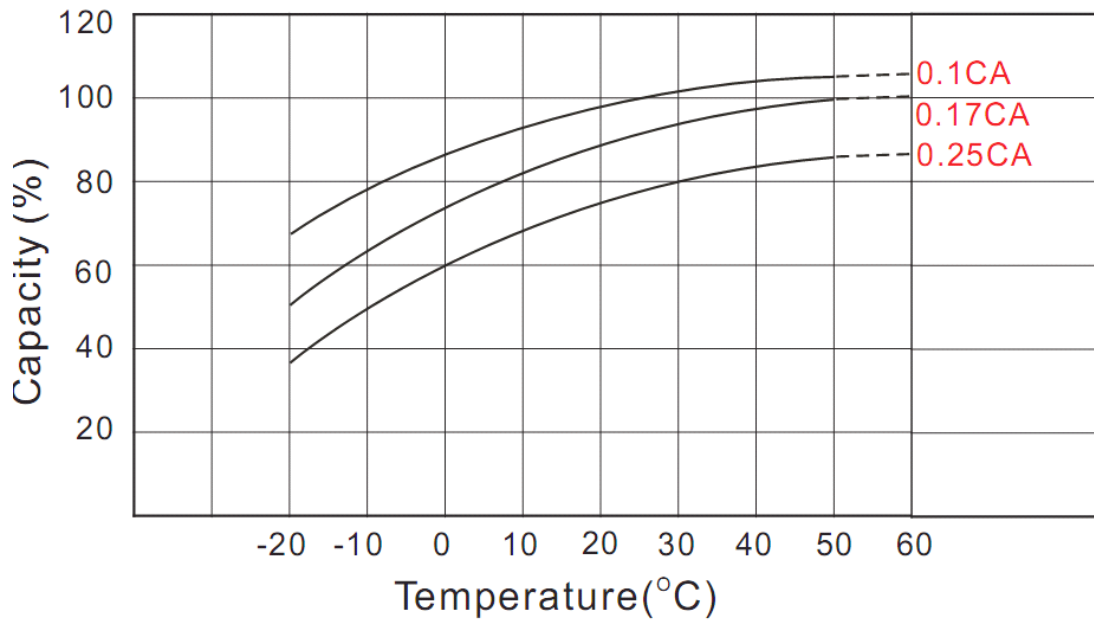

Cycle Life in Relation to Depth of Discharge

Testing condition

Discharging: current 0.17C (FV 1.7V/cell);

Charging: current 0.25C max, voltage 2.45V/cell;

Charging volume: 125% of discharged capacity.

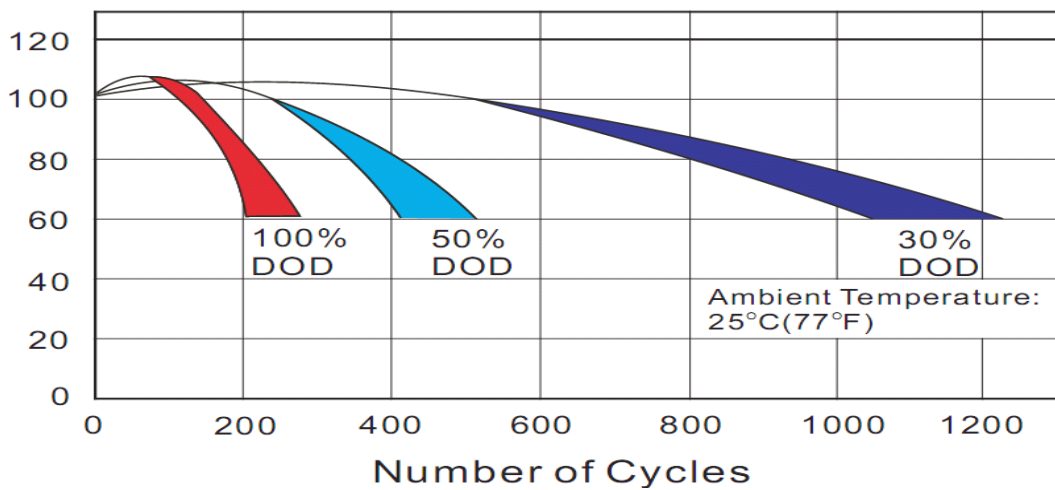

Maintenance and Attention Matters:

1. Battery is not allowed close to Tepid source or basked under the sun for a long time.

2. No charge in the obturate container

3. No short circuit. Battery should be stored full of electronic when not in need, and the battery should be charged every three months in order to avoid the irreversible sulphation. When battery case bursts or electrolyte leaks, battery should be changed lest the acid corrosion.

4. No battery in environment with the acid gas.

5. When battery is used as the backup battery, be careful and check it at regular time to avoid the damage battery. Especially the battery beyond one year should be checked in time, and change the less capacity and scrapped battery. (some batteries maybe have voltage but no current; some batteries maybe have current but no voltage; some maybe have both but less capacity: all these conditions cannot meet the work, reach the power-on time. Do not for the small battery, cause the huge losses)

6. Forbidden battery in the fire, otherwise it will cause an explosion.

7. When battery cracks or electrolyte leaks, please use cotton cloth clear it. When skin contacts to the liquid, please wash with fresh water immediately. See

doctor if serious.

8. No wash on the surface of the battery with the organic solution.

康利达国际控股集团有限公司 KANGLIDA INTERNATIONAL HOLDING GROUP CO., LTD
郑州康利达电子电源有限公司 Zhengzhou Kanglida electronic power Co., LTD
<http://www.cnbattery.cn> <http://www.kliddzdy.com> Tel:86-371-6876444/55628530-816
Fax:86-371-68786444